

Multi Split Inverter Klimaanlage / Wärmepumpe mit drei Innengeräten

Model: CSM10000akl3a

Masszeichnung Aussengerät CSM8000a3

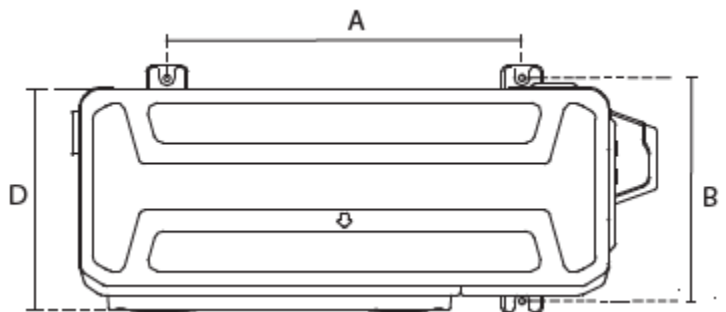
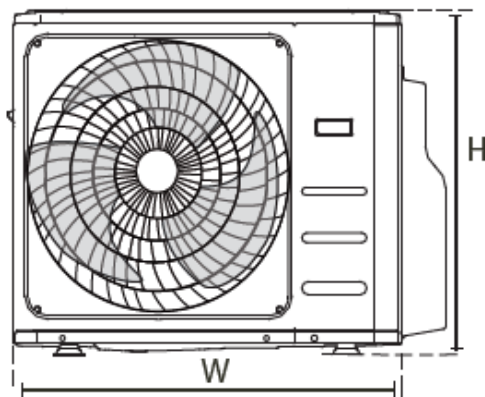

Abmessungen in mm

Abmessungen der Ausseneinheit L x H x T	Montage-Abmessungen	
	Abstand A	Abstand B
845x702x363	540	350

Masszeichnung Innengerät CSMKL2600i (3 Stk.)

Innengerät Luftansaugung

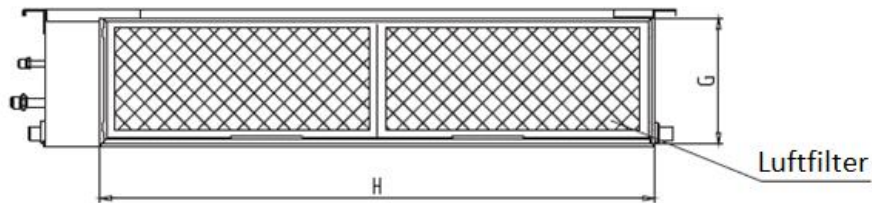

Mass der Luftansaugung	
G	H
190mm	872mm

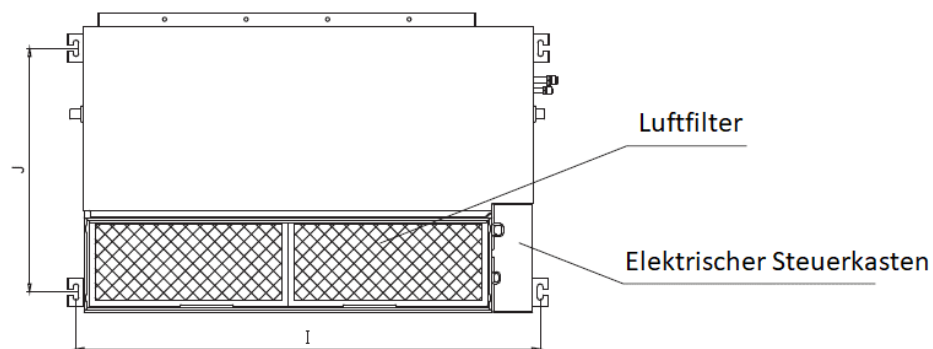

Mass der Montagehalterung	
I	J
920mm	508mm

Innengerät Luftaustritt

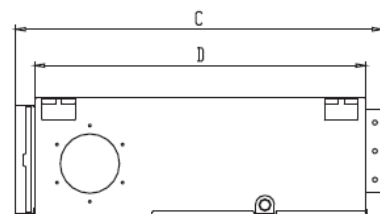
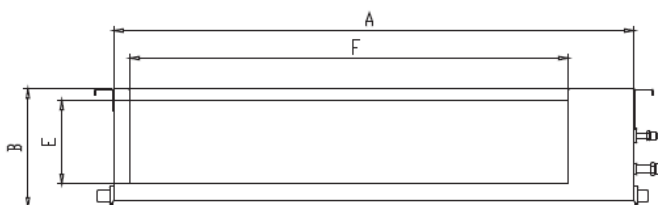

Innengerät Abmessung				Mass der Luftaustrittsöffnung	
A	B	C	D	E	F
880mm	210mm	674mm	600mm	136mm	706mm

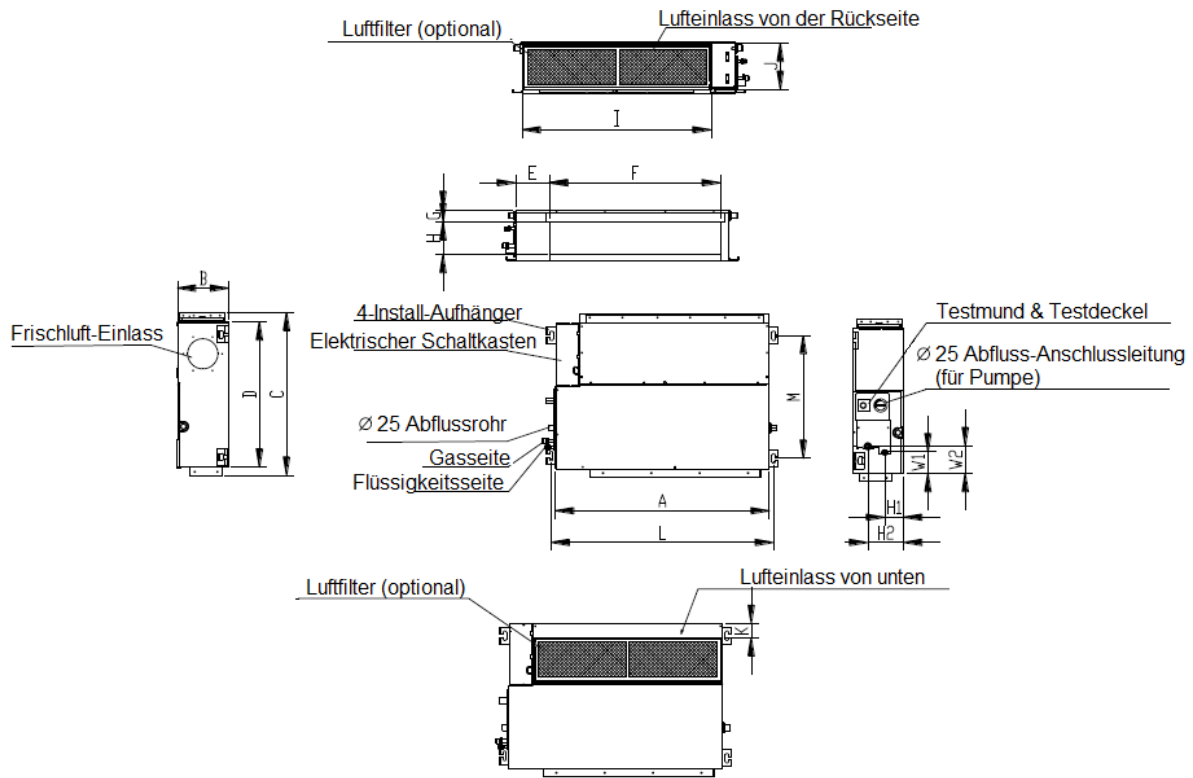

Einheit	A	B	C	D	E	F	G	H	I	J
mm	700	200	506	450	137	537	30	152	599	186

Einheit	K	L	M	H1	H2	W1	W2
mm	50	741	360	84	140	84	84