

## Inverter Split Klimagerät CoolStar CSKL4600i

### Kanalanlage

Model: CSKL4600i

### Innengerät Luftansaugung

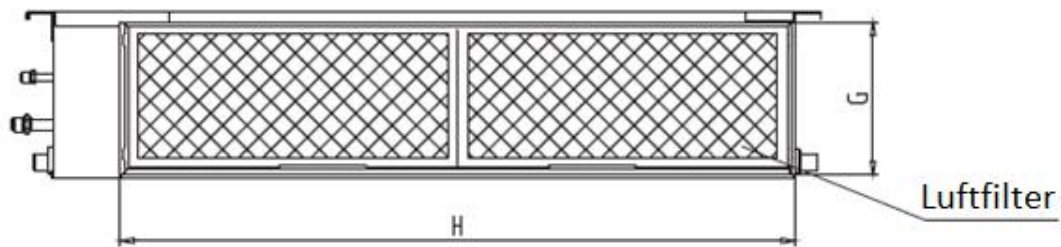

Mass der Luftansaugung	
G	H
190mm	872mm

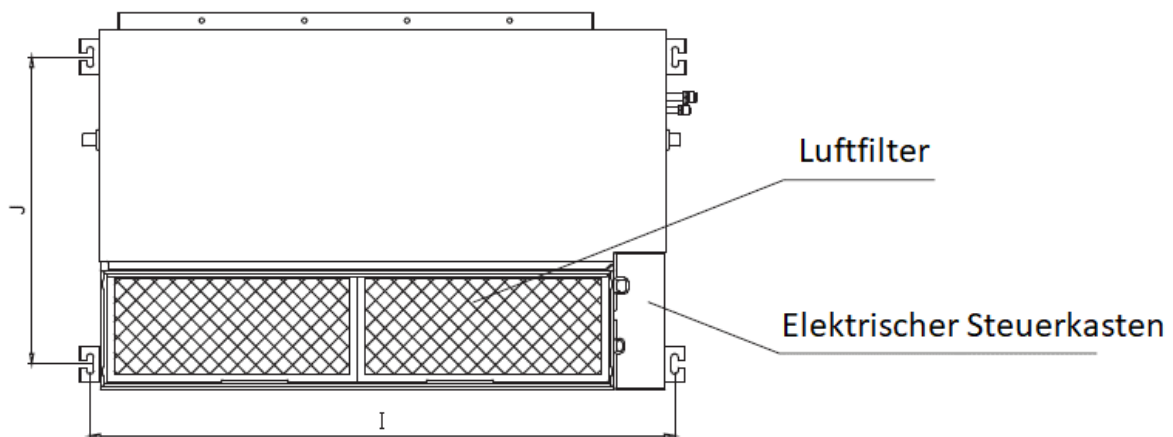

Mass der Montagehalterung	
I	J
920mm	508mm

### Innengerät Luftaustritt

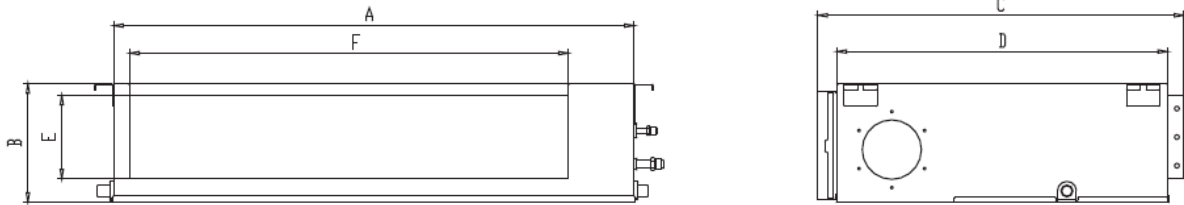

Innengerät Abmessung				Mass der Luftaustrittsöffnung	
A	B	C	D	E	F
880mm	210mm	674mm	600mm	136mm	706mm

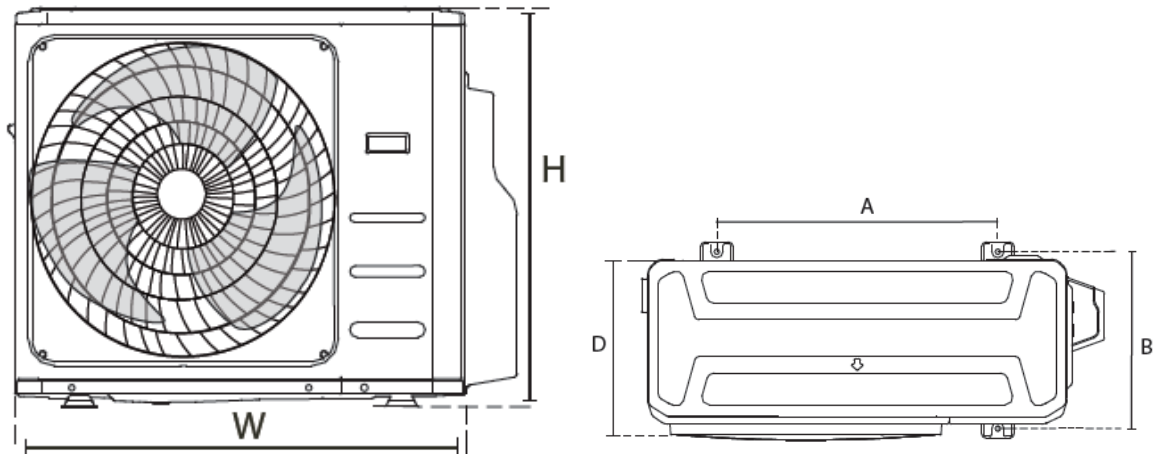

Aussengerät Abmessung			Mass der Montagehalterung	
W	H	D	Distanz A	Distanz B
810mm	558mm	310mm	549mm	325mm