

Inverter Split Klimagerät CoolStar CSKL13000i

Kanalanlage

Model: CSKL13000i

Innengerät Luftansaugung

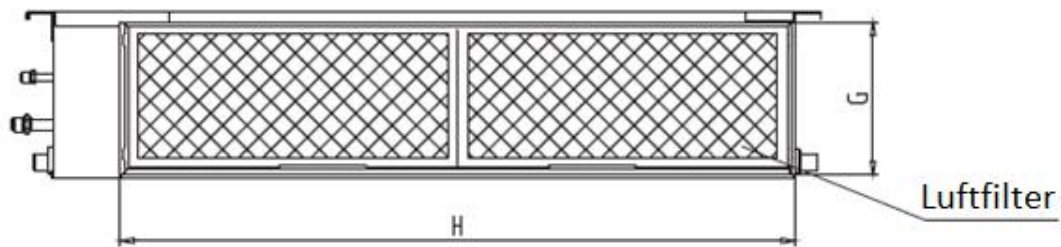

Mass der Luftansaugung	
G	H
280mm	1101mm

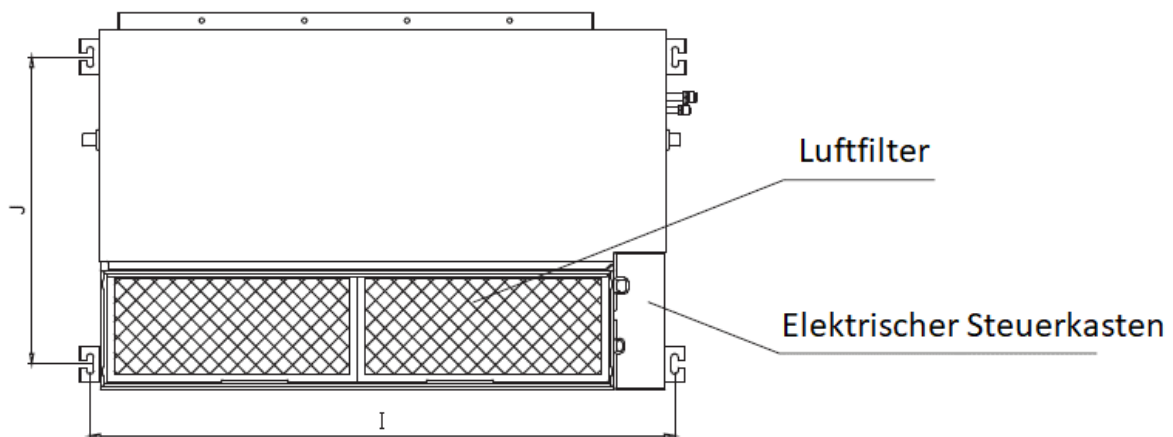

Mass der Montagehalterung	
I	J
1240mm	697mm

Innengerät Luftaustritt

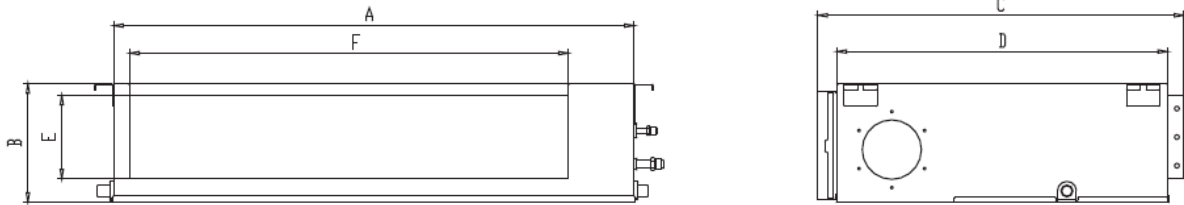

Innengerät Abmessung				Mass der Luftaustrittsöffnung	
A	B	C	D	E	F
1200mm	300mm	874mm	800mm	227mm	1044mm

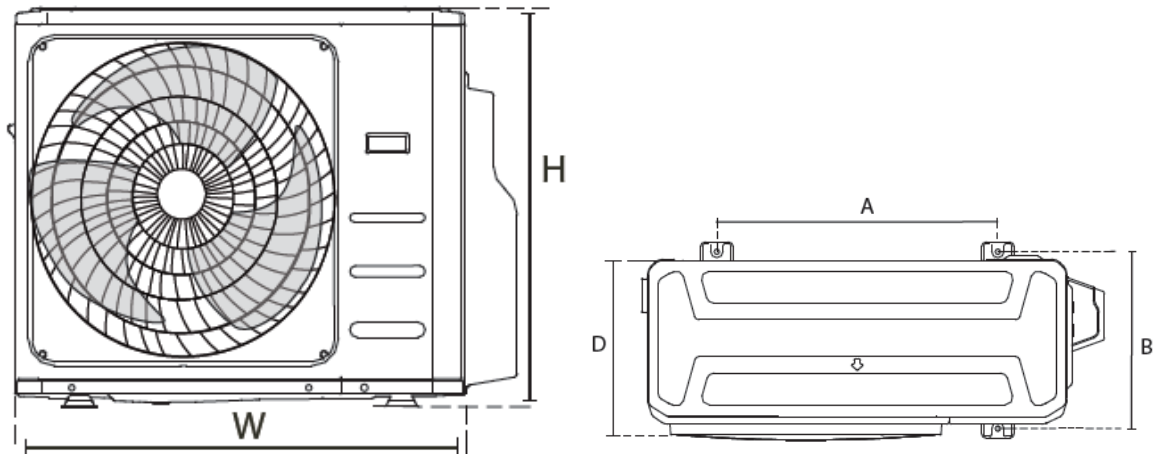

Aussengerät Abmessung			Mass der Montagehalterung	
W	H	D	Distanz A	Distanz B
945mm	810mm	395mm	640mm	405mm