



Inverter Split Klimagerät CoolStar CSD8000i

Decken- Truhengerät

Model: CSD8000i

Innengerät

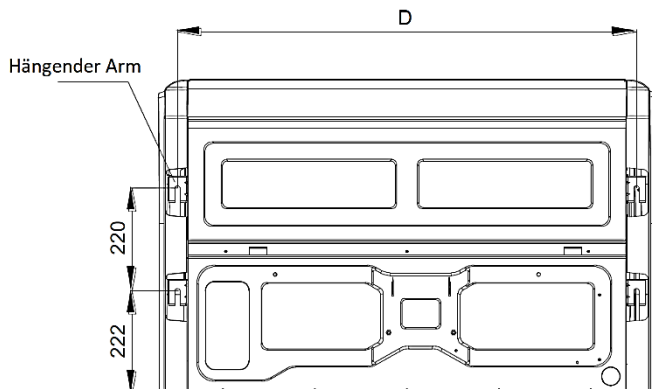
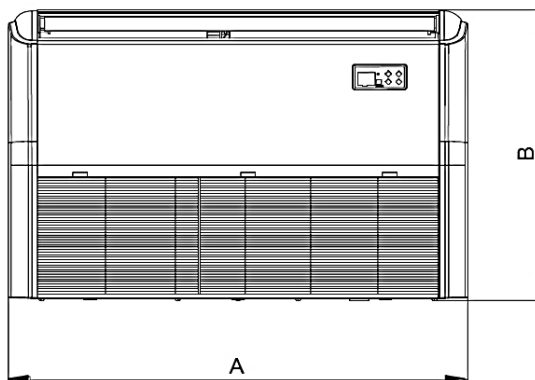
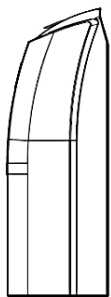
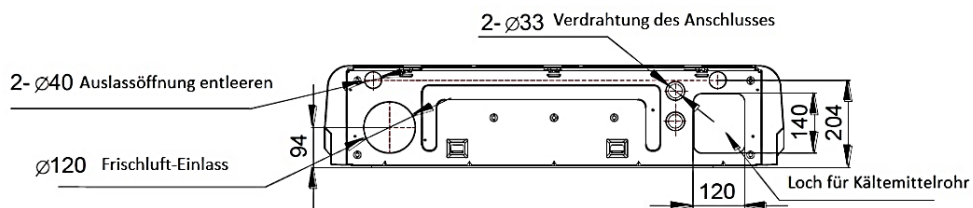

	Abmessungen
A	1068mm
B	675mm
C	235mm
D	983mm

Aussengerät

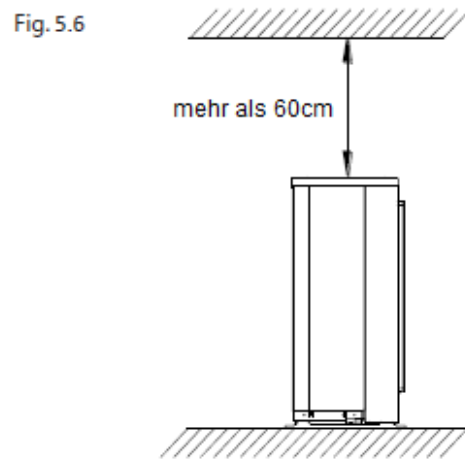
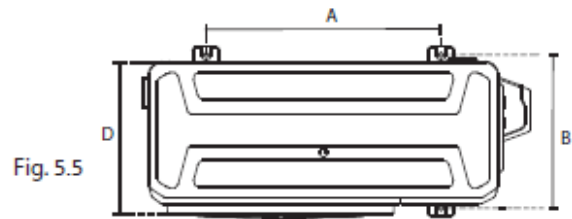
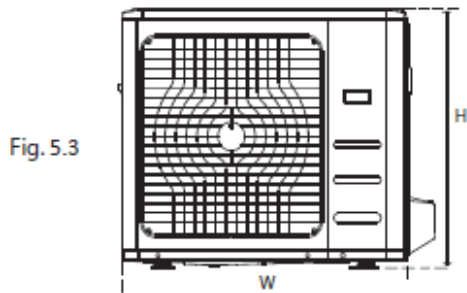

Abmessungen W x D x H	Montage-Abmessungen	
	Entfernung A	Entfernung B
845x363x702mm	540mm	350mm