

Inverter Split Klimagerät CoolStar CSD10000i

Decken- Truhengerät

Model: CSD10000i

Innengerät

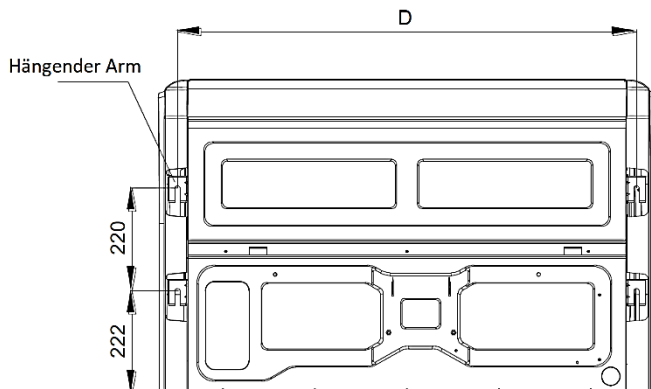
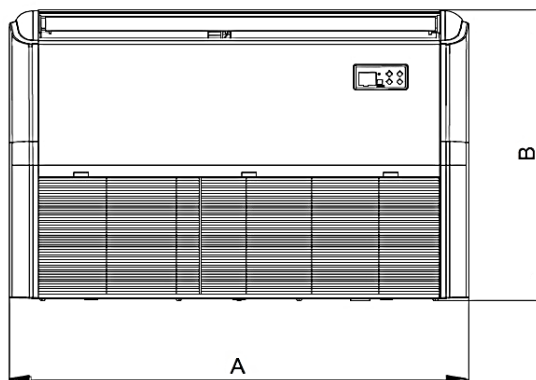
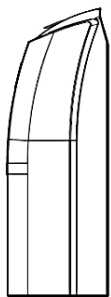
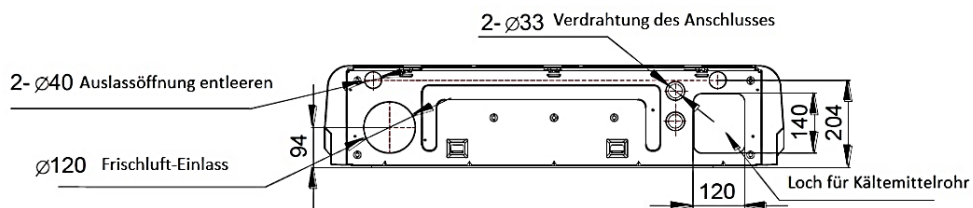

	Abmessungen
A	1285mm
B	675mm
C	235mm
D	1200mm

Aussengerät

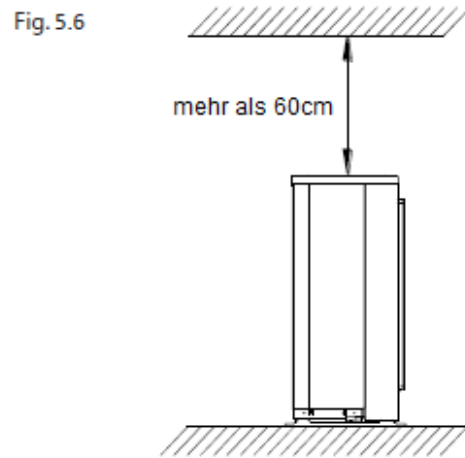
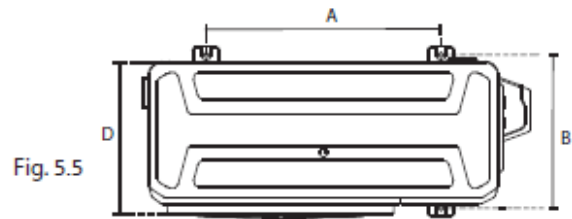
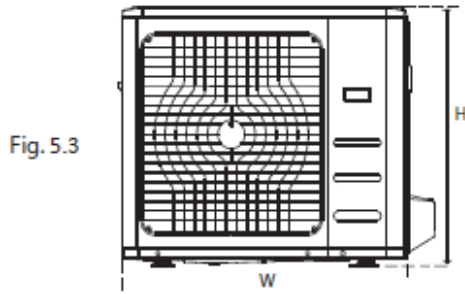

Abmessungen W x D x H	Montage-Abmessungen	
	Entfernung A	Entfernung B
946x410x810mm	673mm	403mm