



Super Inverter Klimaanlage CoolStar CS8000invSEs3m

Innengerät



Abmessungen (LxTxH) mm 1080x226x335

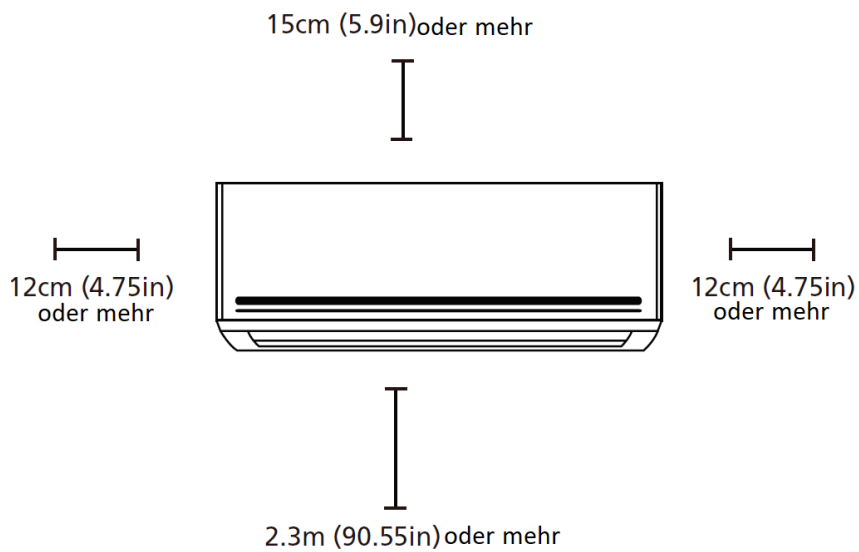

Aussengerät



Abmessungen (LxTxH)

mm

845x363x702

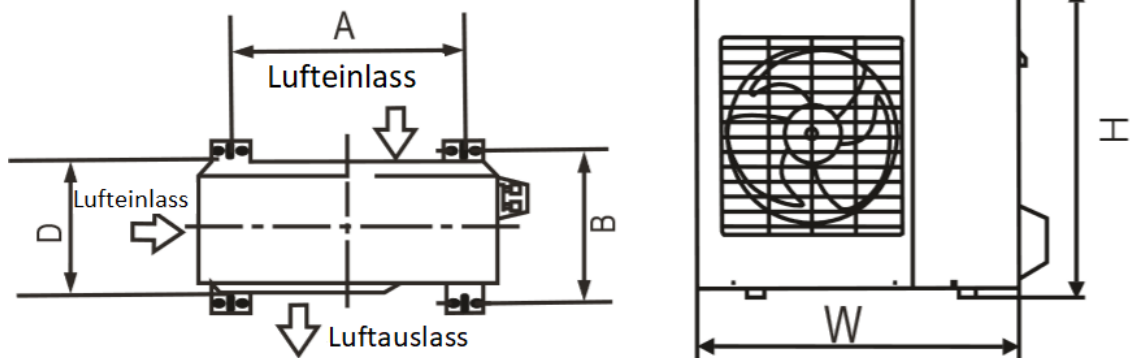

Fig. 4.5

Abstand A	mm	540
Abstand B	mm	350
D	mm	363
W	mm	845
H	mm	702