

Airklima Inverter Wand Klimagerät AK8580svino

Innengerät



Abmessungen (LxTxH)

957x213x302 mm

Montage Innengerät

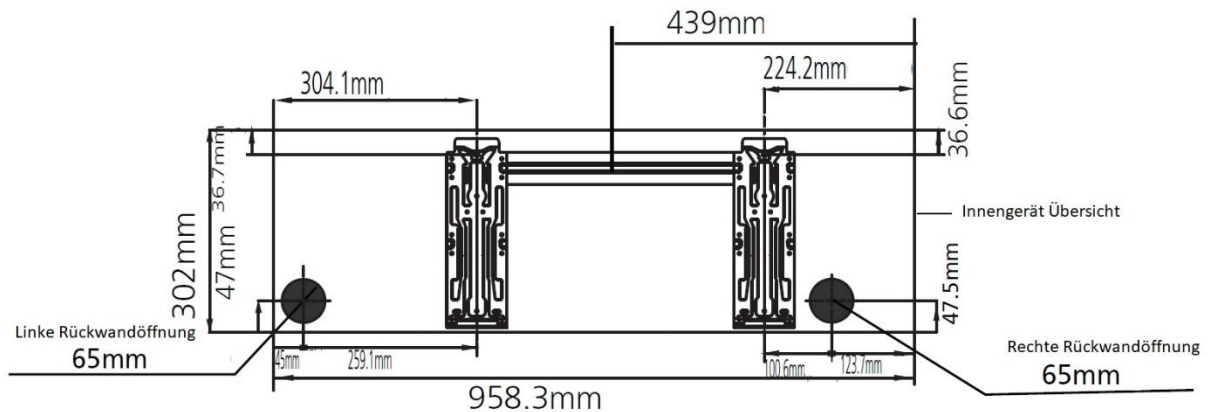

Installation der Montageplatte

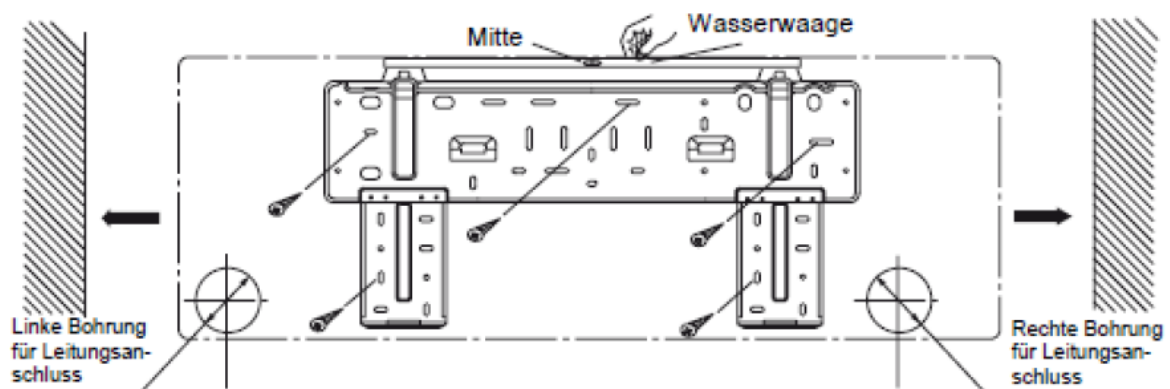

Airklima - Klimaanlage

Aussengerät

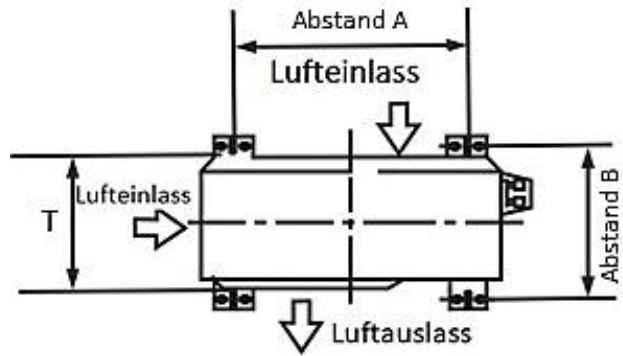
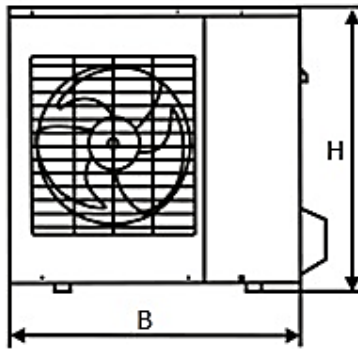

Abmessungen (LxTxH)

800x333x554 mm

Abstand A

514 mm

Abstand B

340 mm

B

800 mm

H

554 mm

T

333 mm