

Airklima

Inverter Klimagerät Airklima AK8540

CE zertifiziert
Eurovent Certified Performance

Model: AK8540

Elektrische Daten

Leistungsaufnahme	kW	0.1 – 1.24
Spannungsversorgung	(V/Phase/Hz)	220, 1, 50
Stromaufnahme	A	4.9
Zuleitung Aussengerät	mm ²	3 x 1.5
Verbindungsleitung	mm ²	5 x 1.5
Absicherung	A	10 -13

Airklima

Modell 1:

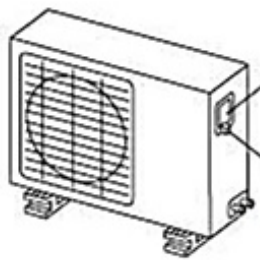
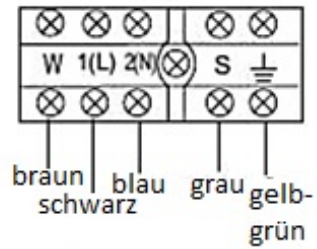
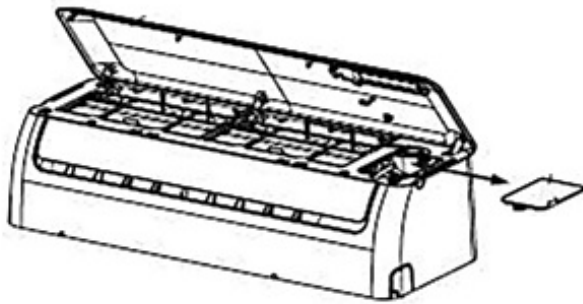

Abdeckung

Schraube

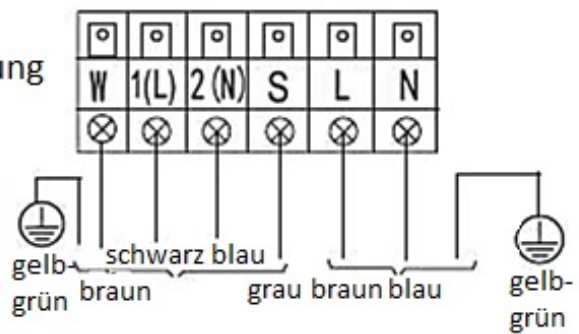

Airklima

Model 2:

